

# Data Sheet

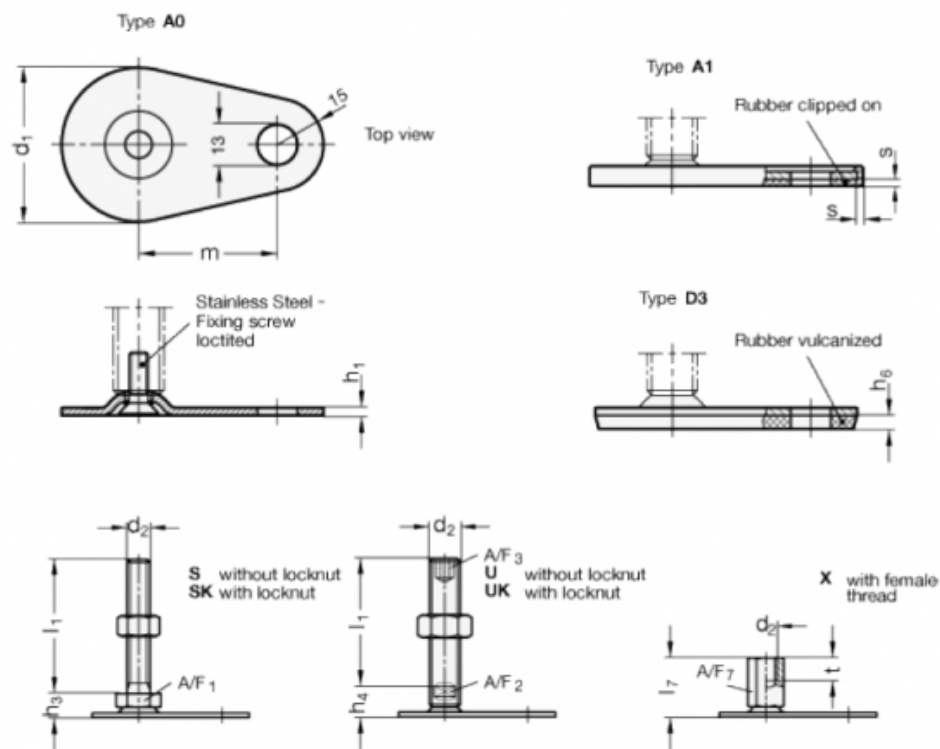

Article number: 204280M826D3X  
 Description: E+G levelling foot  
 GN 42-80-M8-26-D3-X  
 Note: X With female thread, External hexagon

## Measures



A/F7 = 14	t = 8
d1 = 80	
d2 = M8	
h1 = 3	
h6 = 5	
l7 = 26	
m = 70	
s =	